

PROTUM® series

Small, light cable carriers
for modern offices

P0240 GS



Trademarks are legally protected for the TSUBAKI KABELSCHLEPP GmbH
as a national or international registration in the following countries:
tsubaki-kabelschlepp.com/trademarks

Subject to change without notice.

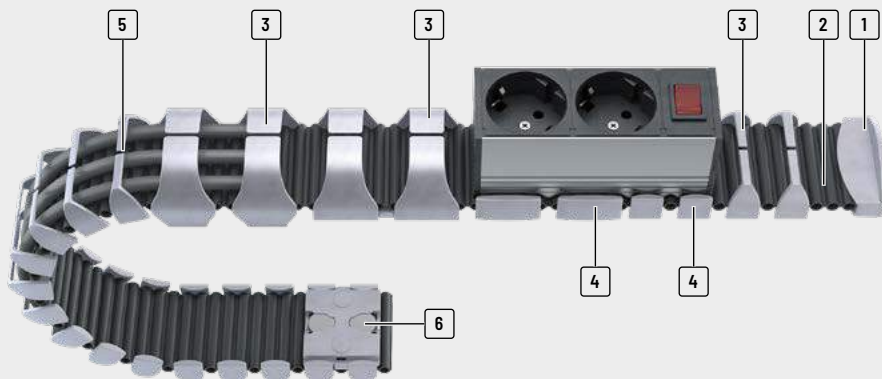

- 1 Variable fastening for table top, table frame, table foot and floor
- 2 Very long service life - no links and therefore no link wear
- 3 Different side parts / inner heights available
- 4 "Clip" side parts for attaching add-on parts
- 5 Cables are simply pressed in
- 6 Variable Befestigung (Tischplatte, Tischgestell, Tischfuß und Boden)

Features

- » Solid plastic cable carrier
- » Cost savings through easy cable installation
- » Installation of pre-assembled cables also possible
- » Belt with clip-on side parts
- » Easy adaptation of the chain length
- » Low weight, good ratio between inner and outer width
- » Combination options for end connectors



Available in the standard color variants black, white, and silver gray



Cables are simply pressed in



The basic structure: belt with clip-on side parts



PROTUM OFFICE for office furniture and interiors

Type	Opening variant	Stay variant	h_i	h_G	B_i	B_k	B_i - grid	t	KR	Additional load \leq [kg/m]	Cable- d_{max} [mm]	
			[mm]	[mm]	[mm]	[mm]	[mm]	[mm]	[mm]			[mm]
P0240 GS												
K series			010	10	23	50	54	-	24	-	-	8
P0400 GS												
UNIFLEX Advanced series			010	21.5	34	50	55	-	40	-	-	8
M series			010	21.5	53.5	50	55	-	40	-	-	8
TKHD series			010	21.5	53.5	50	55	-	40	-	-	8
XL series												
QUANTUM® series												
TKR series												
TKA series												
UAT series												

Unsupported arrangement			Gliding arrangement			Inner Distribution				Movement			Page
Travel length ≤ [m]	$v_{max} \leq [m/s]$	$a_{max} \leq [m/s^2]$	Travel length ≤ [m]	$v_{max} \leq [m/s]$	$a_{max} \leq [m/s^2]$	TS0	TS1	TS2	TS3	vertical hanging or standing	lying on the side	rotating arrangement	

-	-	-	-	-	-	-	-	-	-	(*)	-	-	267
---	---	---	---	---	---	---	---	---	---	-----	---	---	-----

-	-	-	-	-	-	-	-	-	-	(*)	-	-	282
---	---	---	---	---	---	---	---	---	---	-----	---	---	-----

-	-	-	-	-	-	-	-	-	-	(*)	-	-	282
---	---	---	---	---	---	---	---	---	---	-----	---	---	-----

-	-	-	-	-	-	-	-	-	-	(*)	-	-	282
---	---	---	---	---	---	---	---	---	---	-----	---	---	-----

-	-	-	-	-	-	-	-	-	-	(*)	-	-	282
---	---	---	---	---	---	---	---	---	---	-----	---	---	-----

P0240 GS

PROTUM OFFICE

K
seriesPitch
24 mmInner height
10 mmInner width
50 mmUNIFLEX
Advanced
series

This variant for office use is based on the PROTUM® cable carrier system.

design element, e.g. with an elegant silver-grey optic.

With its inner width of 50 mm and cable installation on both sides, PROTUM OFFICE offers sufficient space for telecommunication, energy and data cables in modern offices.

The linkless design can blend into the environment as a

M
series

Small, light cable carrier

- » Long service life – no links and therefore no link wear
- » Good ratio of usable space to outer dimensions
- » Easy installation by pressing in the cables
- » Easy to install and fill
- » Suitable for retrofitting
- » Clean, space-saving installation
- » Can be filled on one or both sides

Easy and fast installation

- » Connections for all smooth surfaces
- » Standard connection for table frame, round and square outside the footwell
- » Up to 4 installation options, depending on connection (magnets, screws, cable ties and adhesive tape)
- » Floor connection for sturdy positioning and floor connection

TKHD
seriesXL
seriesQUANTUM®
series

Stay variants



Design 010..... page 267

Frame with lamellae in the outer radius

- » Belt with clip-on side parts.
- » **One-sided:** for pressing in.

TKR
seriesTKA
seriesUAT
series

Stay variant 010 – with lamellae in the outer radius

- » Belt with clip-on side parts.
- » **Outside:** for pressing in.



Stay arrangement on each chain link (**fully stayed**)



B_i 50 mm

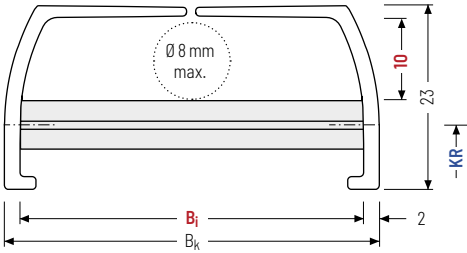

h_i [mm]	h_g [mm]	B_i [mm]	B_k [mm]	q_k [kg/m]
10	23	50	$B_i + 4$	0.28

Standard colors



Black (RAL 9005)
Mat. no. 75637*

White (RAL 9010)
Mat. no. 75645*

Silver-gray (RAL 9023)
Mat. no. 75641*



For bulk buyers, the color variants of the belt, the side parts and the connections can be individually combined on request. Colored items may have color differences.

* Length: 960 mm

PROTUM®
series

K
series

UNIFLEX
Advanced
series

M
series

TKHD
series

XL
series

QUANTUM®
series

TKR
series

TKA
series

UAT
series

Combination options for end connectors

Depending on the design of your office furniture, different combination options are possible for the end connectors. They can be attached underneath table tops/cable conduits, to round or square table legs or to the floor.

Combination options for tables without height adjustment

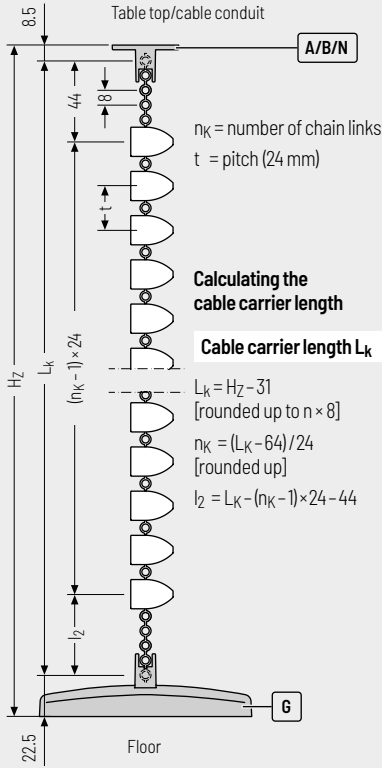

Combination options for tables with height adjustment

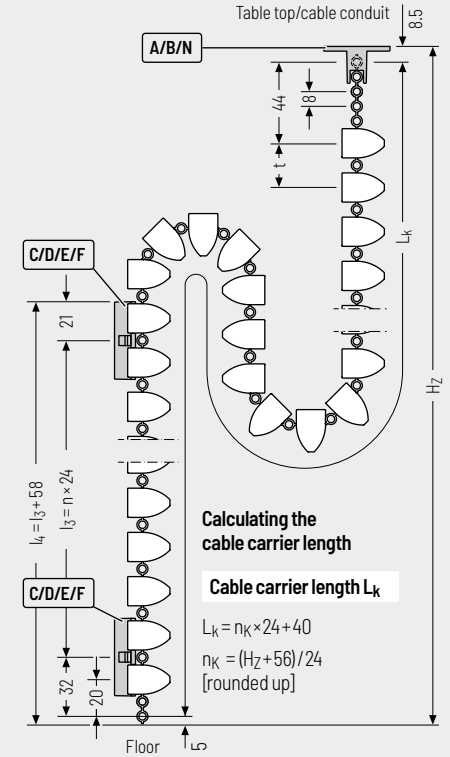

End connectors

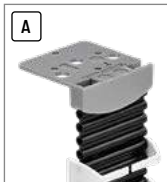

Page 270



Page 270

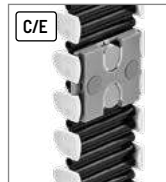

Page 271



Page 271

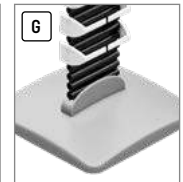

Page 272



All connections and cable carriers can be combined with each other and are available in the colour variants silver-grey, black and white.

Combination options for end connectors

Depending on the design of your office furniture, different combination options are possible for the end connectors. They can be attached underneath table tops/cable conduits, to round or square table legs or to the floor.

Combination options for tables with height adjustment

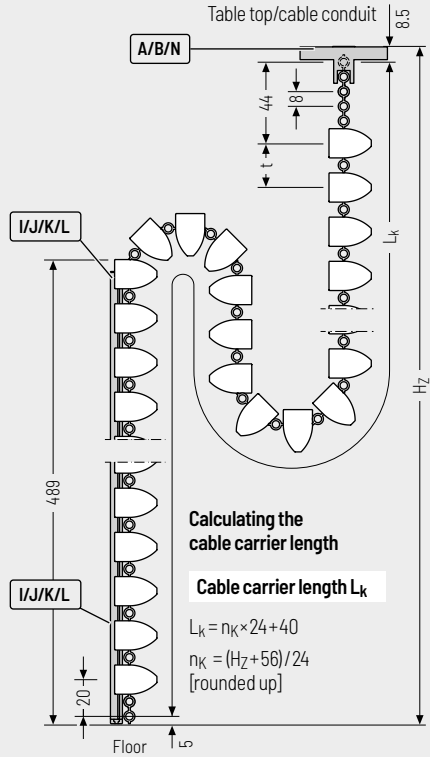
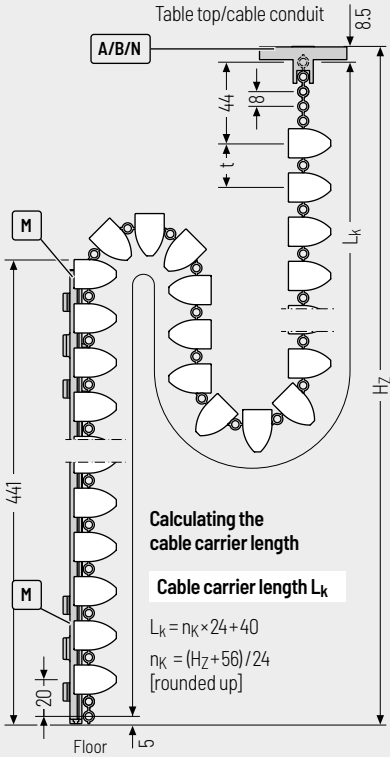

End connectors



Page 272

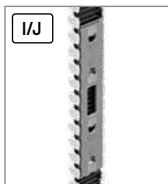

Page 273

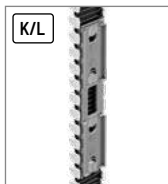

Page 274

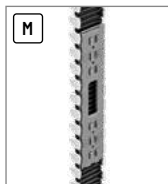

Page 275



Page 276

Subject to change without notice.

All connections and cable carriers can be combined with each other and are available in the colour variants silver-grey, black and white.

PROTUM® series

K series

UNIFLEX Advanced series

M series

TKHD series

XL series

QUANTUM® series

TKR series

TKA series

UAT series

Connection A – angled for table top

Table connection for screw-fixing the cable routing underneath the table top or on a cable conduit.

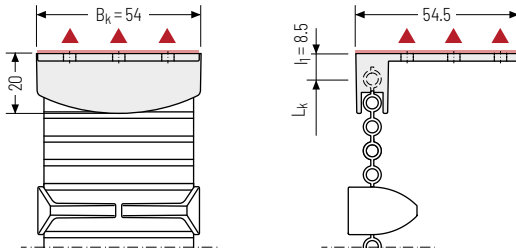

▲ Installation options

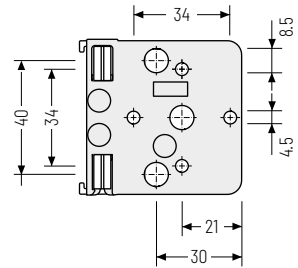

Fixing variant

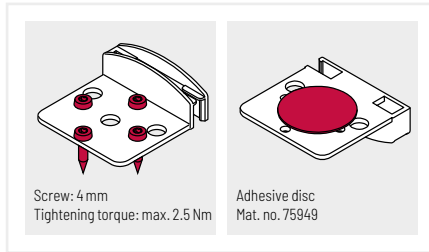

Color variants

- Black
Mat. no. 75739*
- White
Mat. no. 75884*
- Silver-gray
Mat. no. 75876*

*SU = 50 pieces

Connection B – oval for table top

Table connection for screw-fixing the cable routing underneath the table top or on a cable conduit.

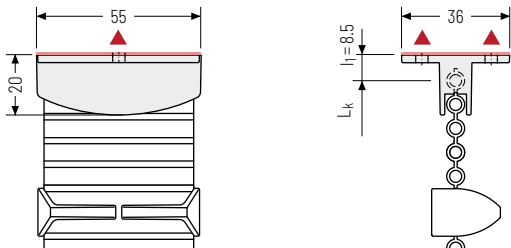

▲ Installation options

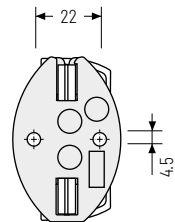

Fixing variant

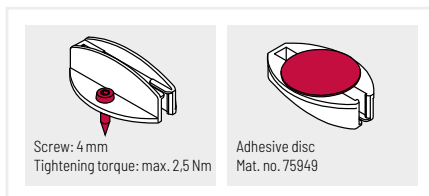

Color variants

- Black
Mat. no. 75740*
- White
Mat. no. 75885*
- Silver-gray
Mat. no. 75877*

*SU = 50 pieces

Also available as magnetic version (Connector N) see p. 276

PROTUM®
series

K
series

UNIFLEX
Advanced
series

M
series

TKHD
series

XL
series

QUANTUM®
series

TKR
series

TKA
series

UAT
series

Connection C/E – for flat table frame

Connection for installing the cable routing on a square table frame.
Fixing with integrated magnets, screws or cable ties.

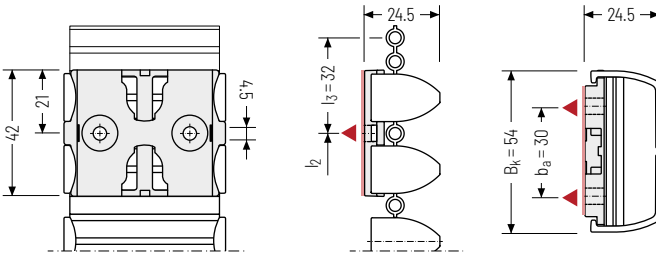



▲ Installation options

 Self-adhesive counterholder available for non-magnetic surfaces!

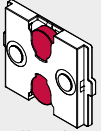
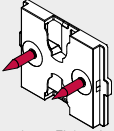
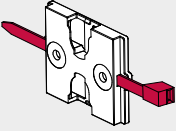
Fixing variants

<p>Connection E</p>  <p>Magnets. Magnetic retention force: max. 40 N</p>	<p>Connection C</p>  <p>Screw: 4 mm, Tightening torque: max. 2.5 Nm</p>	<p>Connection C</p>  <p>Cable tie: 5 mm</p>
--	---	---

Color variants

-  Black
(E) Mat. no. 75741*
(C) Mat. no. 75742*
-  White
(E) Mat. no. 75886*
(C) Mat. no. 75887*
-  Silver-gray
(E) Mat. no. 75878*
(C) Mat. no. 75879*

*SU = 50 pieces

Connection D/F – for round table frame

Connection for installing the cable routing on a table frame with 70 mm diameter.
Fixing with integrated magnets, screws or cable ties.

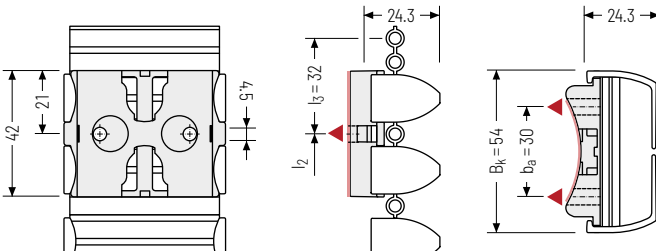

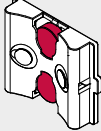
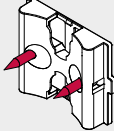
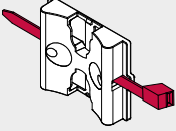

▲ Installation options

Fixing variants

<p>Connection F</p>  <p>Magnets. Magnetic retention force: max. 40 N</p>	<p>Connection D</p>  <p>Screw: 4 mm, Tightening torque: max. 2.5 Nm</p>	<p>Connection D</p>  <p>Cable tie: 5 mm</p>
--	---	---

Color variants

-  Black
(F) Mat. no. 75744*
(D) Mat. no. 75743*
-  White
(F) Mat. no. 75888*
(D) Mat. no. 75889*
-  Silver-gray
(F) Mat. no. 75880*
(D) Mat. no. 75881*

*SU = 50 pieces

PROTUM® series	K series
UNIFLEX Advanced series	M series
TKHD series	XL series
QUANTUM® series	TKR series
TKA series	TKA series
UAT series	

Connection G – floor connection

Floor connection for a clean transition of the cable routing to the floor.
Individual colors and designs on request.

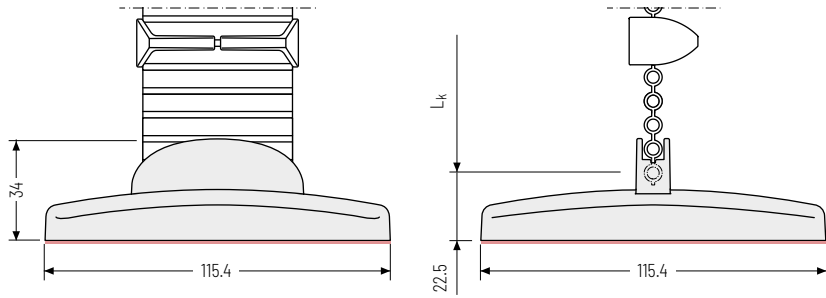
**Color variants**

Black
Mat. no. 75745*



White
Mat. no. 75890*



Silver-gray
Mat. no. 75882*

*SU = 50 pieces

Connection H – for table base

Connection for installing the cable routing on a table base.
Fixing by clipping.

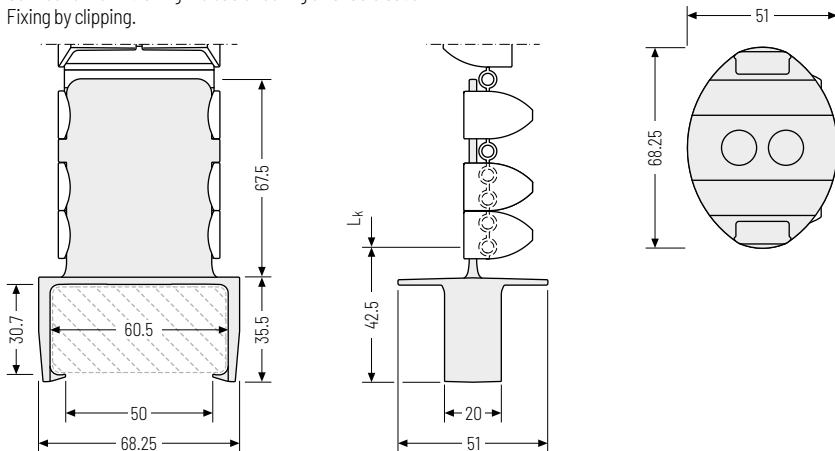
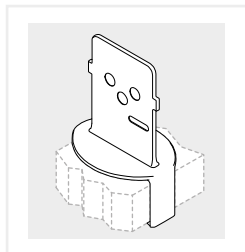
**Fixing variant****Color variants**

Black
Mat. no. 75992*



White
Mat. no. 75994*



Silver-gray
Mat. no. 75993*

*SU = 50 pieces

Connection I/J - for flat table frame

Connection for installing the cable routing on a square table frame. Fixing with integrated magnets or screws.

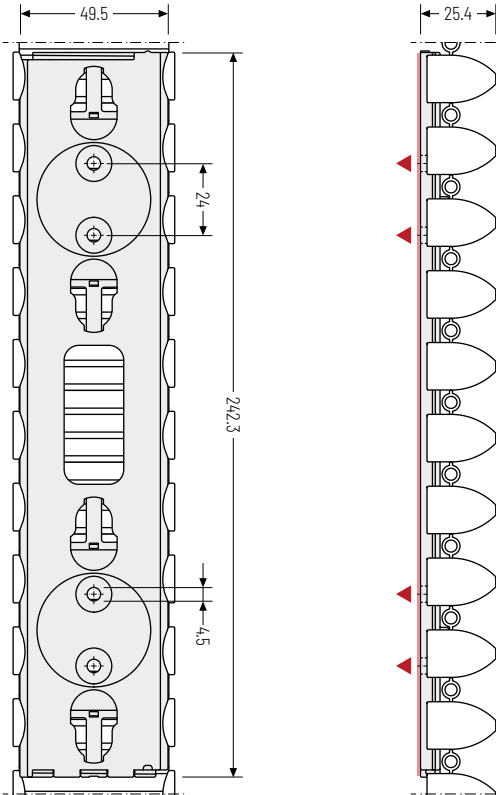

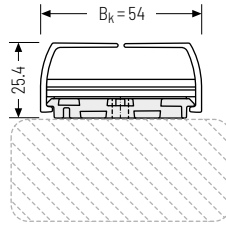

▲ Installation options



 Self-adhesive counterholder available for non-magnetic surfaces!

Color variants

-  Black
(I) Mat. no. 75940*
(J) Mat. no. 75634*
-  White
(I) Mat. no. 75941*
(J) Mat. no. 75635*
-  Silver-gray
(I) Mat. no. 75942*
(J) Mat. no. 75636*

*SU = 50 pieces

Fixing variants

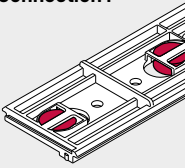
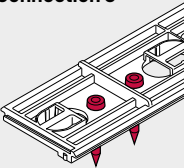
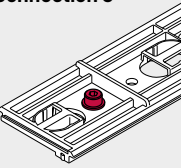
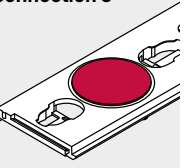
<p>Connection I</p>  <p>Up to 4 magnets, Magnetic retention force: min. 60 N</p>	<p>Connection J</p>  <p>Up to 4 Screws: 4 mm Tightening torque: max. 2.5 Nm</p>	<p>Connection J</p>  <p>For slot nut M4 Cylinder screw: DIN 9612 M4 Washer: DIN 125</p>	<p>Connection J</p>  <p>Adhesive disc Mat. no. 75949</p>
--	---	---	--

PROTUM® series
K series
UNIFLEX Advanced series
M series
TKHD series
XL series
QUANTUM® series
TKR series
TKA series
UAT series

Connection K/L - for round table frame

Connection for installing the cable routing on a table frame with 70 mm diameter. Fixing with integrated magnets or screws.

▲ Installation options

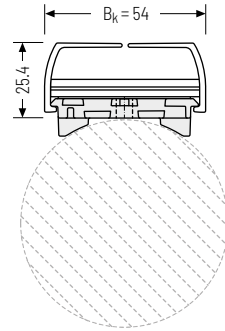
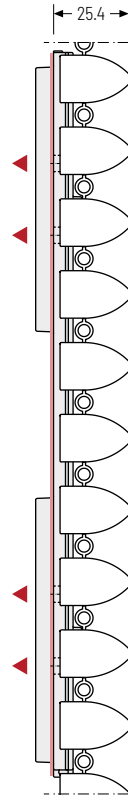
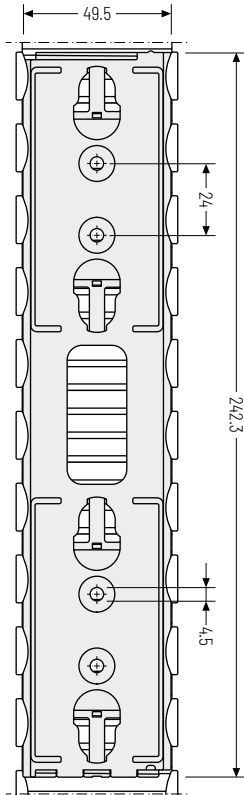

Individual diameters on request.

Color variants

- Black
(K) Mat. no. 75943*
(L) Mat. no. 75647*
- White
(K) Mat. no. 75944*
(L) Mat. no. 75648*
- Silver-gray
(K) Mat. no. 75945*
(L) Mat. no. 75649*

*SU = 50 pieces

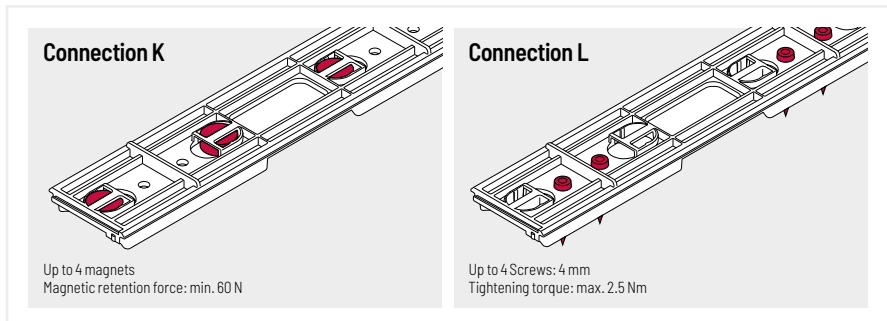
Fixing variants

Connection M – for profiles flat

Connection for installing the cable routing on aluminum profiles rectangular. Fixing via integrated clip.

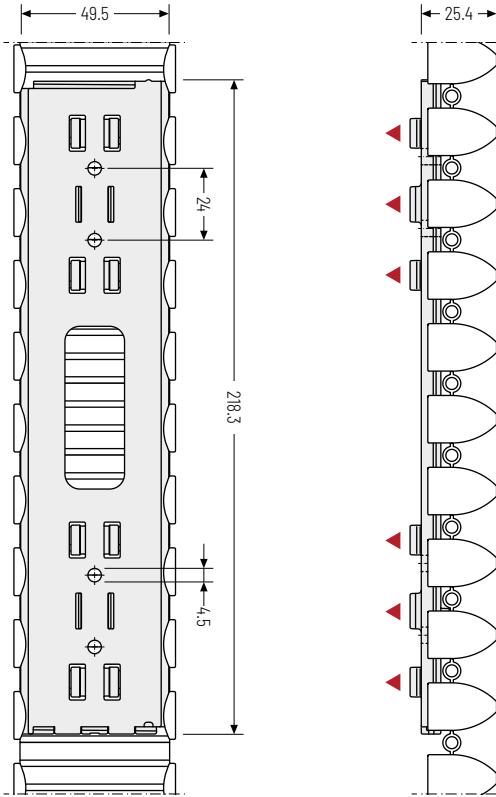

▲ Installation options

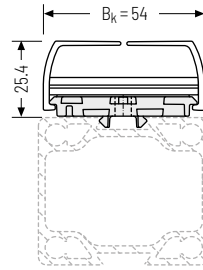

i Individual profile cross-section on request.

Color variants

- Black
Mat. no. 75937*
- White
Mat. no. 75938*
- Silver-gray
Mat. no. 75939*

*SU = 50 pieces

Fixing variant

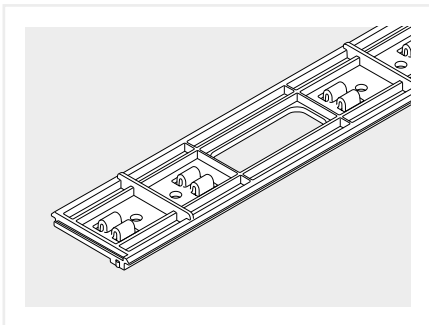

i The assembly depends on the shape of the aluminum profile. Please contact us – we are happy to advise you

Connection N – oval for table top

Table connection for installing the cable routing underneath the table top or on a cable conduit via integrated magnets.

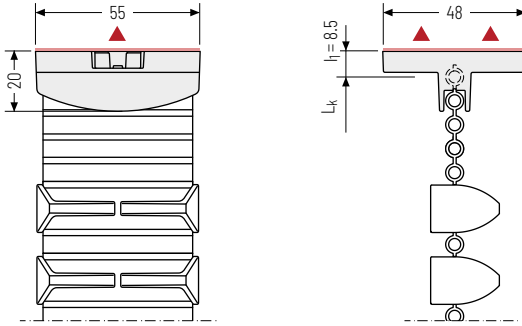

▲ Installation options

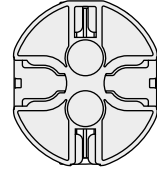

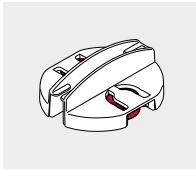

 Self-adhesive counterholder available for non-magnetic surfaces!

Fixing variant

Magnets
Magnetic retention
force:
max. 35 N

Color variants

-  Black
Mat. no. 75937*
-  White
Mat. no. 75938*
-  Silver-gray
Mat. no. 75939*

*SU = 50 pieces

Side parts „Clip“ – Fixing kit for connection on both sides

Connection for installing the cable routing and attachments such as connector strips, adapters and much more. Fixing with integrated magnets or screws.

▲ Installation options

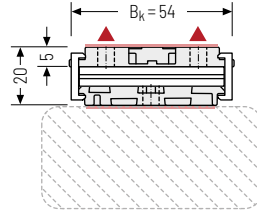
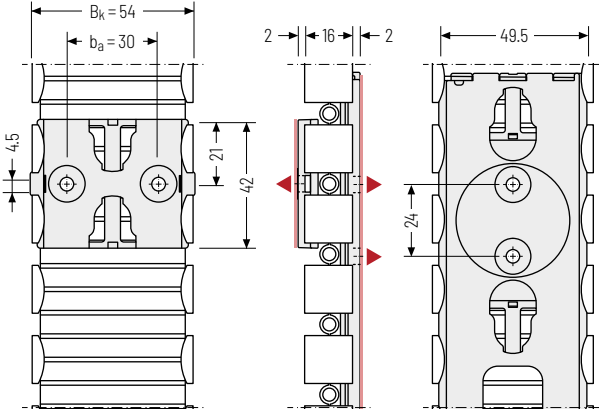

i Self-adhesive counterholder available for non-magnetic surfaces!

The fixing kit includes the belt and the side parts "Clip" for a length of 480 mm. The side parts "Clip" can be combined with the following connectors:

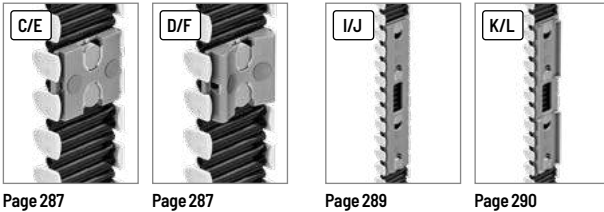

Page 287

Page 287

Page 289

Page 290

Color variants

- Black
Mat. no. 75815*
- White
Mat. no. 75817*
- Silver-gray
Mat. no. 75816*

* Length: 480 mm



Side parts „Clip“

Subject to change without notice.

PROTUM®
series

K series

UNIFLEX
Advanced series

M series

TKHD series

XL series

QUANTUM® series

TKR series





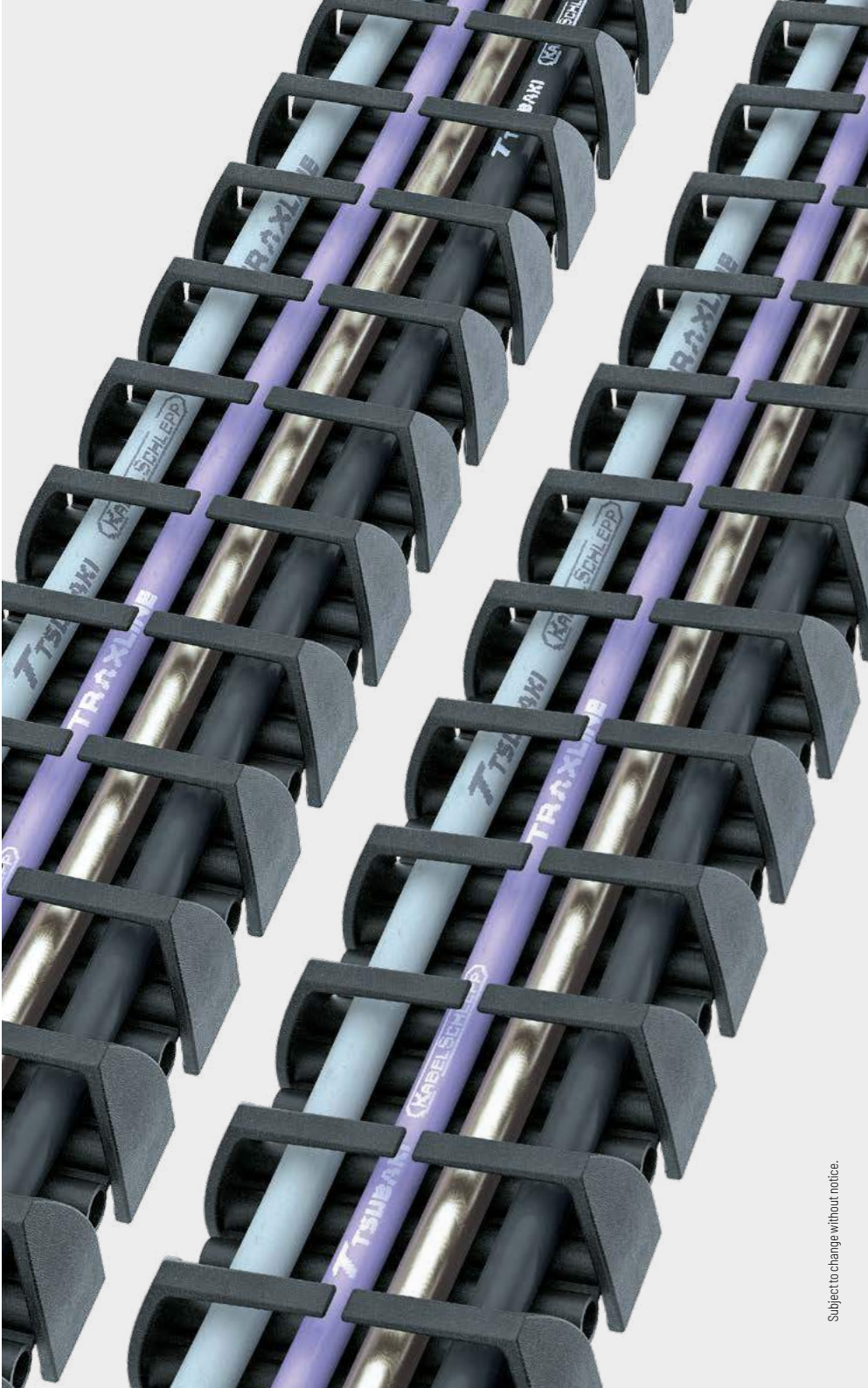

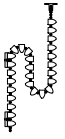

TKA series

UAT series

K
seriesUNIFLEX
Advanced
seriesM
seriesTKHD
seriesXL
seriesQUANTUM®
seriesTKR
seriesTKA
seriesUAT
series

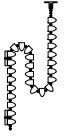
Order





Standard sets for height-adjustable tables (standing/seated work stations) up to 740 mm lifting height

		Color	Order no. Set
	Standard set Protum Office P0240GS for standing/seated work station for one-sided cable laying , total length 1350 mm incl. 1 connection B and 2 connections F for installation underneath a table top and on a round table frame (D = 70 mm)	 Black	75905
		 White	75907
		 Silver-gray	75906
	Standard set Protum Office P0240GS for standing/seated work station for one-sided cable laying , total length 1350 mm incl. 1 connection B and 2 connections E for installation underneath a table top and on a flat table frame	 Schwarz	75901
		 White	75903
		 Silver-gray	75902





Standard sets for non-height adjustable tables (standard work stations)

		Color	Order no. Set
	Standard set Protum Office P0240GS for standard work station for one-sided cable laying , total length 815 mm incl. 1 connection B and 1 connection C for installation underneath a table top and the floor transition	 Black	75896
		 White	75898
		 Silver-gray	75897

Standard sets for attaching a power strip

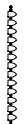
		Color	Order no. Set
	Standard set of "Clip" side parts for attaching a power strip . Fastening set for attaching on both sides . Total length 480 mm.	 Black	75815
		 White	75817
		 Silver-gray	75816

Standard sets for cable routing P0240GS

		Color	Order no. Set
	Standard set for cable routing Protum Office P0240GS , inner cross section 50 x 10 mm, total length 960 mm.	 Black	75637
		 White	75645
		 Silver-gray	75641

All sets are delivered packaged in a box including fixing materials and installation instructions. The order number applies for 1 set / 1 sales unit (SU) = 50 sets. Individual sets only for bulk buyers on request.

PROTUM® series

K series

UNIFLEX Advanced series

M series

TKHD series

XL series

QUANTUM® series

TKR series

TKA series

UAT series



P0400 GS

PROTUM OFFICE



Pitch
40 mm



Inner height
21.5 mm



Inner width
50 – 52 mm

This variant for office use is based on the PROTUM® cable carrier system.

With its inner width of 50 mm and cable installation on both sides, PROTUM OFFICE offers sufficient space for telecommunication, energy and data cables in modern offices.

The linkless design can blend into the environment as a

design element, e.g. with an elegant silver-grey optic.

Small, light cable carrier

- » Long service life – no links and therefore no link wear
- » Good ratio of usable space to outer dimensions
- » Easy installation by pressing in the cables
- » Easy to install and fill
- » Suitable for retrofitting
- » Clean, space-saving installation
- » Can be filled on one or both sides

Easy and fast installation

- » Connections for all smooth surfaces
- » Standard connection for table frame, round and square outside the footwell
- » Up to 4 installation options, depending on connection (magnets, screws, cable ties and adhesive tape)
- » Floor connection for sturdy positioning and floor connection
- » Complete separation of data and power cables

Stay variants



P0400GS01 (one-sided) page 282

Frame with lamellae in the outer radius

- » Belt with clip-on side parts.
- » **One-sided:** for pressing in.



P0400GS02 (double-sided) page 282

Frame with lamellae in the outer and inner radius

- » Belt with clip-on side parts.
- » **Double-sided:** for pressing in.



Stay variant 010 -

with lamellae in the outer or
outer and inner radius

- » Belt with clip-on side parts.
- » **One-sided/Double-sided:**
for pressing in.

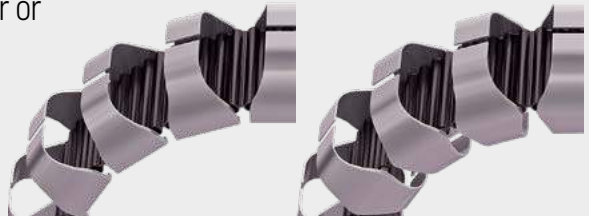

Stay arrangement on each
chain link (**fully stayed**)



B_i 50 mm

P0400GS01

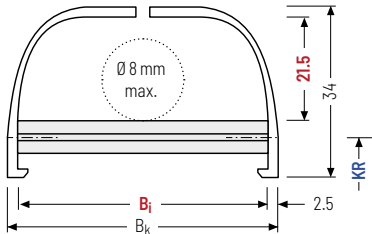

P0400GS02

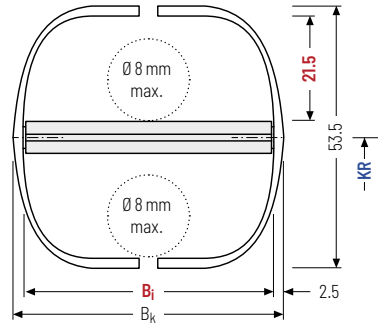

Design	h_i [mm]	h_G [mm]	B_i [mm]	B_k [mm]	q_k [kg/m]
P0400GS01 (one-sided)	21.5	34	50	$B_i + 5$	0.286
P0400GS02 (double-sided)	21.5	53.5	50	$B_i + 5$	0.336

Standard colours

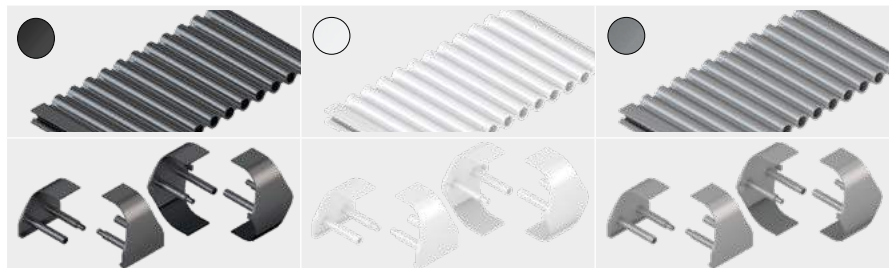

Black (RAL 9005)
P0400GS01 Mat. no. 75972*
P0400GS02 Mat. no. 75981*

White (RAL 9010)
P0400GS01 Mat. no. 75980*
P0400GS02 Mat. no. 75989*

Silver-grey (RAL 9023)
P0400GS01 Mat. no. 75976*
P0400GS02 Mat. no. 75985*



For bulk buyers, the colour variants of the belt, the side parts and the connections can be individually combined on request. Colored items may have color differences.

* Length: 960 mm

Stay variant 010
Module combination – with lamellae in the outer radius

- » Belt with clip-on side and middle parts.
- » Modules can be combined with one another as required.
- » **One-sided:** for pressing in.

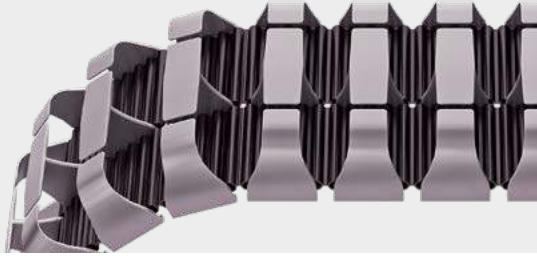

Stay arrangement on each chain link (**fully stayed**)



B_i 51/52 mm

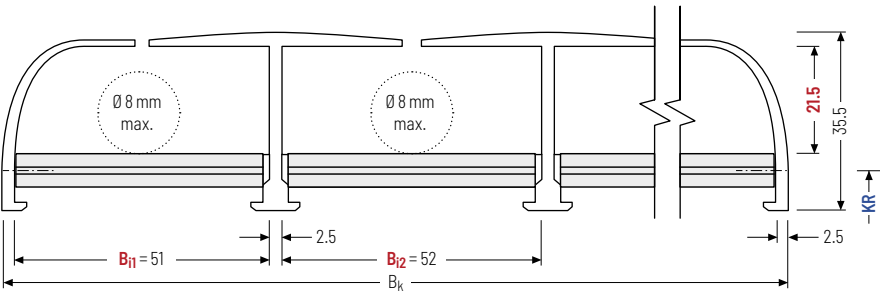

Design	Chamber	h_i [mm]	h_G [mm]	B_i [mm]	B_k [mm]	q_k [kg/m]
P0400GS01.2	2	21.5	35.5	2x51	109.5	0.608
P0400GS01.3	3	21.5	35.5	2x51 + 1x52	164.0	0.911
P0400GS01.4	4	21.5	35.5	2x51 + 2x52	218.5	1.215
P0400GS01.5	5	21.5	35.5	2x51 + 3x52	273.0	1.519

Standard colours

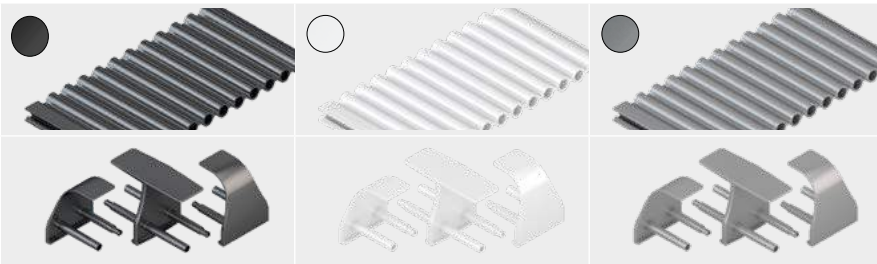

Black (RAL 9005)
 P0400GS01.2 Mat. no. 75855*

White (RAL 9010)
 P0400GS01.2 Mat. no. 75857*

Silver-grey (RAL 9023)
 P0400GS01.2 Mat. no. 75856*

Subject to change without notice.

For bulk buyers, the colored variants of the belt, the side parts and the connections, as well as the modules can be individually combined on request. Colored items may have color differences.

* Length: 960 mm

PROTUM® series

K series

UNIFLEX Advanced series

M series

TKHD series

XL series

QUANTUM® series

TKR series

TKA series

UAT series

Combination options for end connectors

Depending on the design of your office furniture, different combination options are possible for the end connectors. They can be attached underneath table tops/cable conduits, to round or square table legs or to the floor.

Combination options for tables without height adjustment

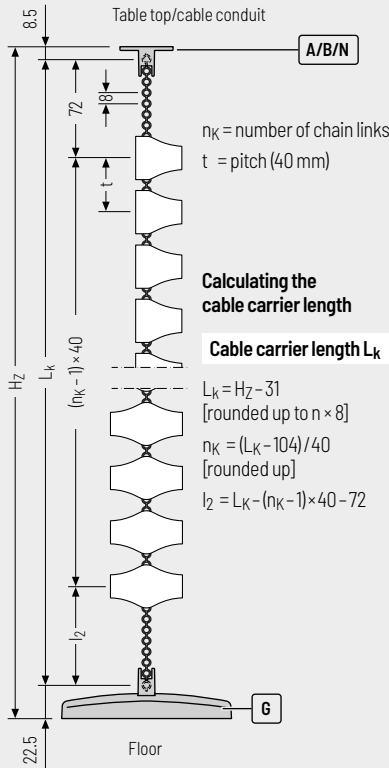

Calculating the cable carrier length

Cable carrier length L_k

$$L_k = Hz - 31$$

[rounded up to n × 8]

$$n_k = (L_k - 104) / 40$$

[rounded up]

$$l_2 = L_k - (n_k - 1) \times 40 - 72$$

Combination options for tables with height adjustment (only one-sided variant)

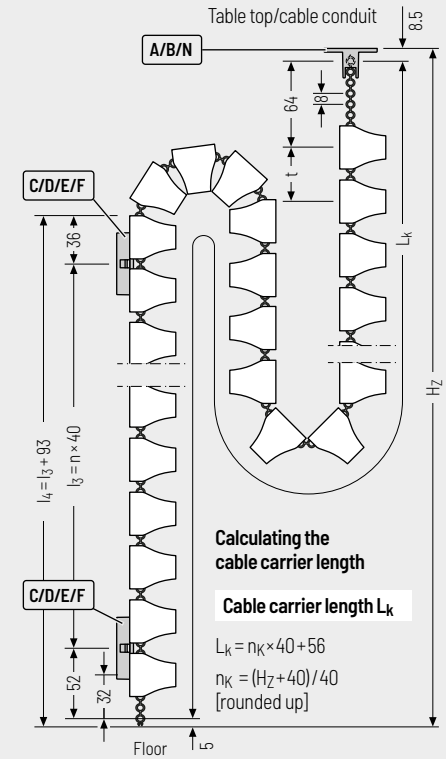

Calculating the cable carrier length

Cable carrier length L_k

$$L_k = n_k \times 40 + 56$$

$$n_k = (Hz + 40) / 40$$

[rounded up]

End connectors

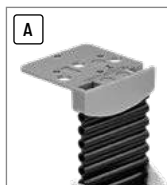

Page 286



Page 286

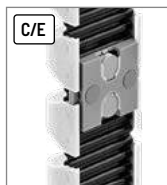

Page 287



Page 287



Page 288



All connections and cable carriers can be combined with each other and are available in the colour variants silver-grey, black and white.

Combination options for end connectors

Depending on the design of your office furniture, different combination options are possible for the end connectors. They can be attached underneath table tops/cable conduits, to round or square table legs or to the floor.

Combination options for tables with height adjustment (only one-sided variant)

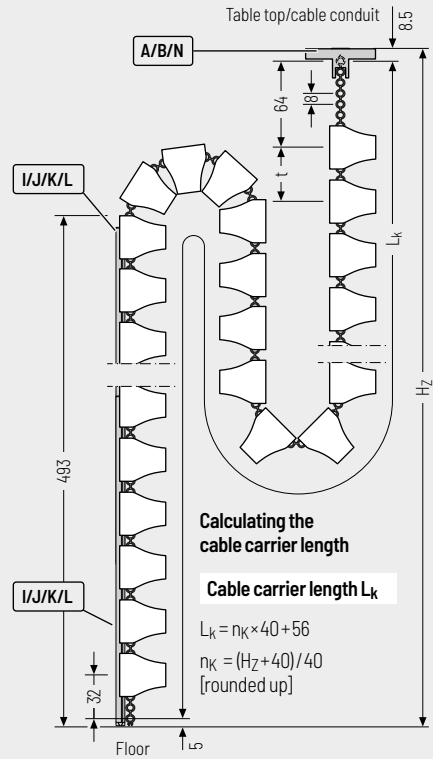
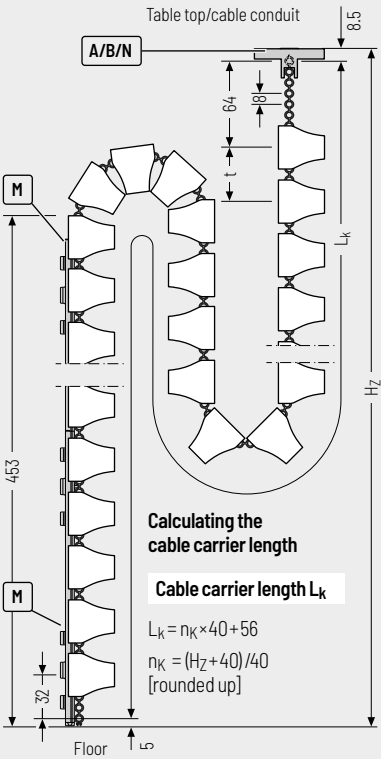

End connectors



Page 288

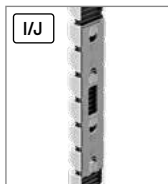

Page 289

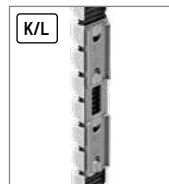

Page 290

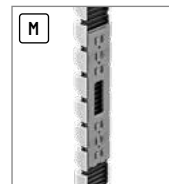

Page 291

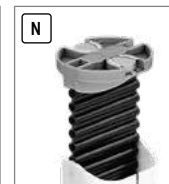

Page 292

Subject to change without notice.

 All connections and cable carriers can be combined with each other and are available in the colour variants silver-grey, black and white.

PROTUM® series

K series

UNIFLEX Advanced series

M series

TKHD series

XL series

QUANTUM® series

TKR series

TKA series

UAT series

Connection A – angled for table top

Table connection for screw-fixing the cable routing underneath the table top or on a cable conduit.

▲ Installation options

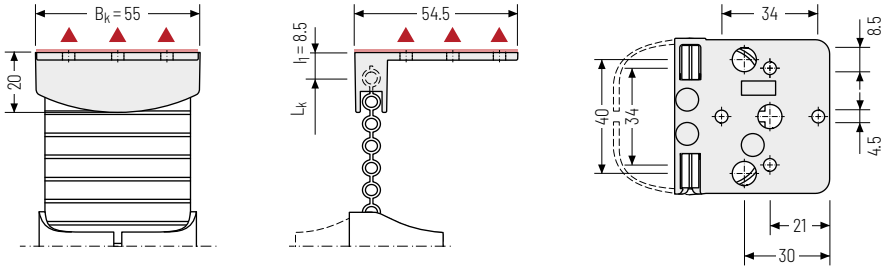

Fixing variant

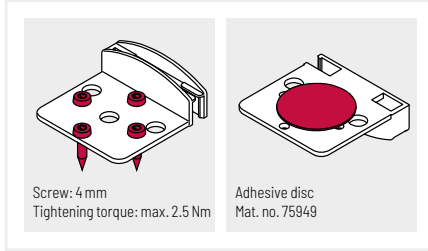

Color variants

- Black
Mat. no. 75739*
- White
Mat. no. 75884*
- Silver-gray
Mat. no. 75876*

*SU = 50 pieces

Connection B – oval for table top

Table connection for screw-fixing the cable routing underneath the table top or on a cable conduit.

▲ Installation options

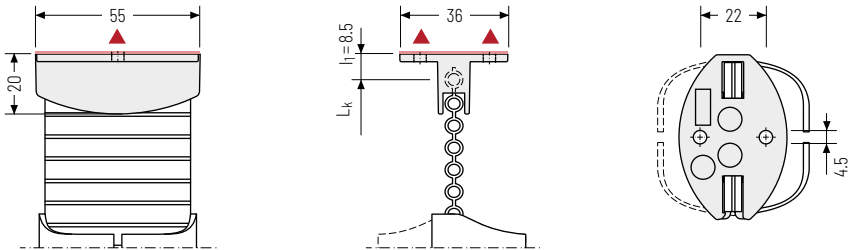

Fixing variant

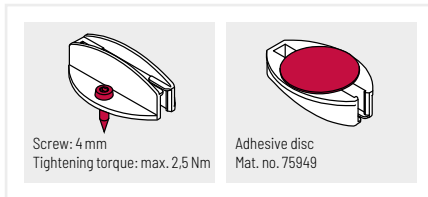

Color variants

- Black
Mat. no. 75740*
- White
Mat. no. 75885*
- Silver-gray
Mat. no. 75877*

*SU = 50 pieces

Also available as magnetic version (Connector N) see p. 276

PROTUM® series
 K series
 UNIFLEX Advanced series
 M series
 TKHD series
 XL series
 QUANTUM® series
 TKR series
 TKA series
 UAT series

Connection C/E – for flat table frame

Connection for installing the cable routing on a square table frame.
Fixing with integrated magnets, screws or cable ties.

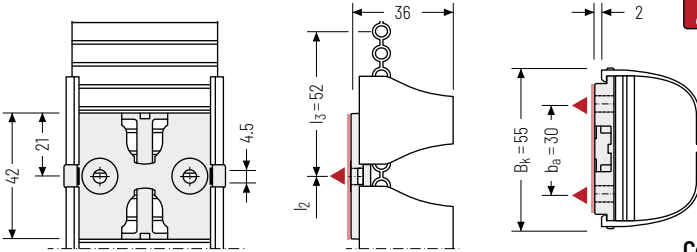

▲ Installation options

Self-adhesive counterholder available for non-magnetic surfaces!

Fixing variants

<p>Connection E</p> <p>Magnets, Magnetic retention force: max. 40 N</p>	<p>Connection C</p> <p>Screw: 4 mm, Tightening torque: max. 2.5 Nm</p>	<p>Connection C</p> <p>Cable tie: 5 mm</p>
--	---	---

Color variants

- Black
(E) Mat. no. 75741*
(C) Mat. no. 75742*
- White
(E) Mat. no. 75886*
(C) Mat. no. 75887*
- Silver-gray
(E) Mat. no. 75878*
(C) Mat. no. 75879*

*SU=50 pieces

Connection D/F – for round table frame

Connection for installing the cable routing on a table frame with 70 mm diameter.
Fixing with integrated magnets, screws or cable ties.

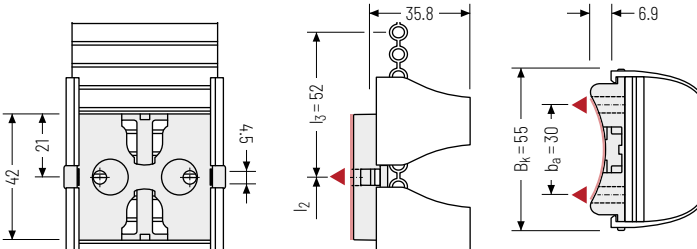

▲ Installation options

Fixing variants

<p>Connection F</p> <p>Magnets, Magnetic retention force: max. 40 N</p>	<p>Connection D</p> <p>Screw: 4 mm, Tightening torque: max. 2.5 Nm</p>	<p>Connection D</p> <p>Cable tie: 5 mm</p>
--	---	---

Color variants

- Black
(F) Mat. no. 75744*
(D) Mat. no. 75743*
- White
(F) Mat. no. 75888*
(D) Mat. no. 75889*
- Silver-gray
(F) Mat. no. 75880*
(D) Mat. no. 75881*

*SU=50 pieces

PROTUM® series	K series
UNIFLEX Advanced series	M series
TKHD series	XL series
QUANTUM® series	TKR series
TKA series	TKA series
UAT series	UAT series

Connection G – floor connection

Floor connection for a clean transition of the cable routing to the floor.
Individual colors and designs on request.

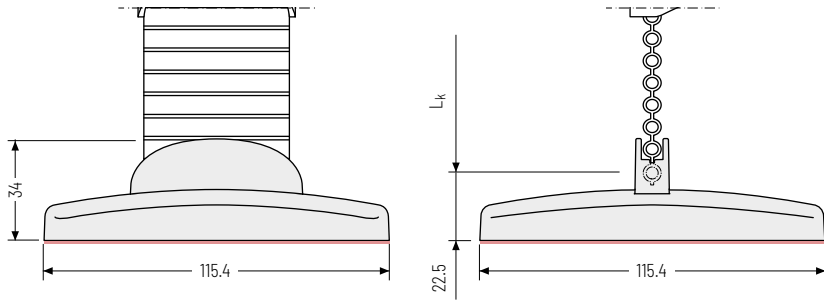
**Color variants**

Black
Mat. no. 75745*



White
Mat. no. 75890*



Silver-gray
Mat. no. 75882*

*SU = 50 pieces

Connection H – for table base

Connection for installing the cable routing on a table base.
Fixing by clipping.

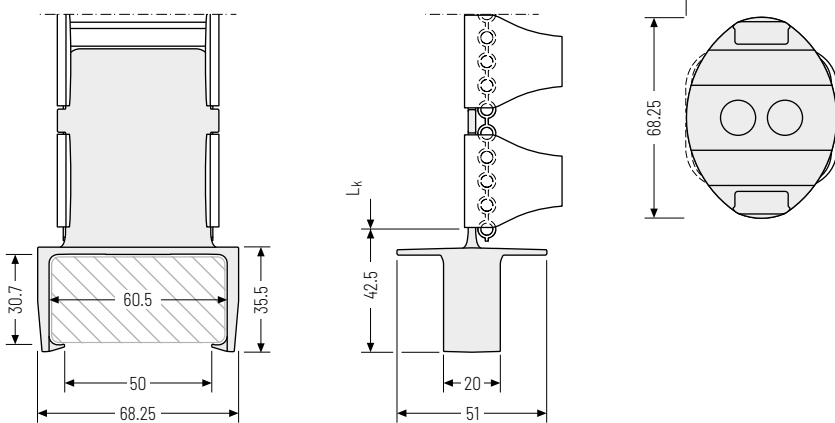
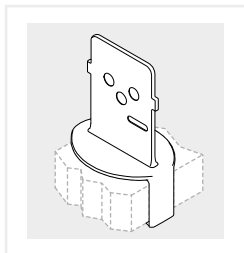
**Fixing variant****Color variants**

Black
Mat. no. 75992*



White
Mat. no. 75994*



Silver-gray
Mat. no. 75993*

*SU = 50 pieces

Connection I/J – for flat table frame

Connection for installing the cable routing on a square table frame.
Fixing with integrated magnets or screws.

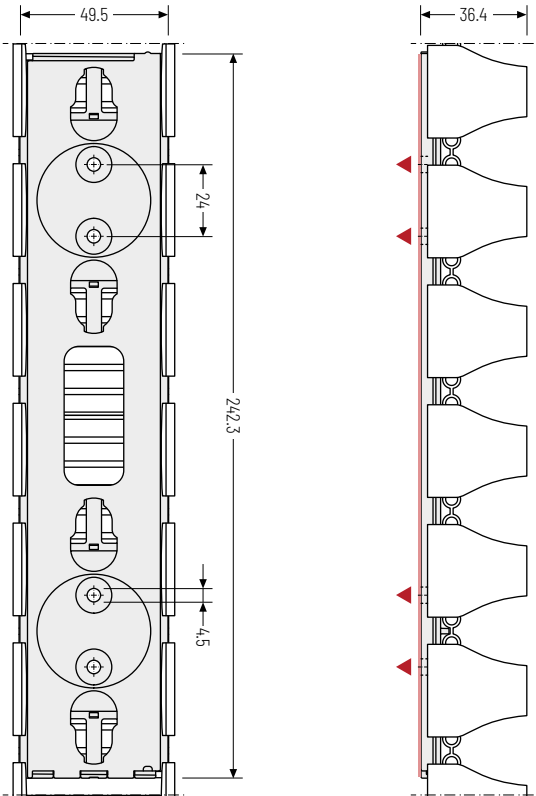

▲ Installation options

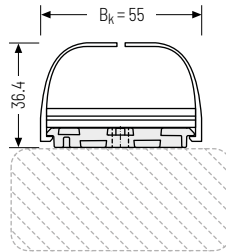

Self-adhesive counterholder available for non-magnetic surfaces!

Color variants

- Black
(I) Mat. no. 75940*
(J) Mat. no. 75634*
- White
(I) Mat. no. 75941*
(J) Mat. no. 75635*
- Silver-gray
(I) Mat. no. 75942*
(J) Mat. no. 75636*

*SU = 50 pieces

Fixing variants

<p>Connection I</p> <p>Up to 4 magnets, Magnetic retention force: min. 60 N</p>	<p>Connection J</p> <p>Up to 4 Screws: 4 mm Tightening torque: max. 2.5 Nm</p>	<p>Connection J</p> <p>For slot nut M4 Cylinder screw: DIN 9612 M4 Washer: DIN 125</p>	<p>Connection J</p> <p>Adhesive disc Mat. no. 75949</p>
--	---	---	--

Subject to change without notice.

PROTUM® series	K series
UNIFLEX Advanced series	M series
TKHD series	XL series
QUANTUM® series	TKR series
TKA series	UAT series

Connection K/L - for round table frame

Connection for installing the cable routing on a table frame with 70 mm diameter. Fixing with integrated magnets or screws.

▲ Installation options

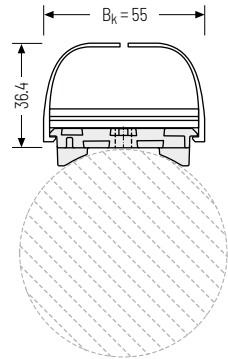
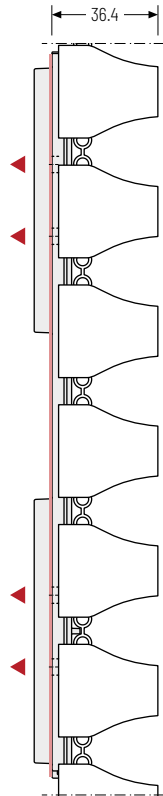
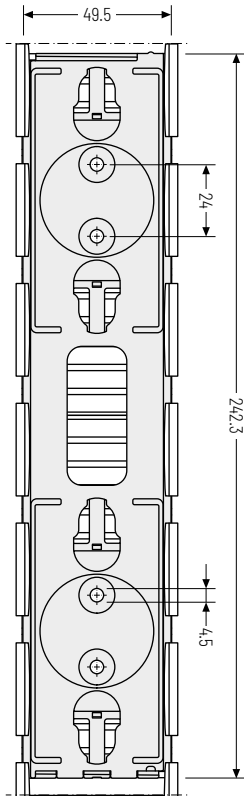

Individual diameters on request.

Color variants

- Black
(K) Mat. no. 75943*
(L) Mat. no. 75647*
- White
(K) Mat. no. 75944*
(L) Mat. no. 75648*
- Silver-gray
(K) Mat. no. 75945*
(L) Mat. no. 75649*

*SU = 50 pieces

Fixing variants

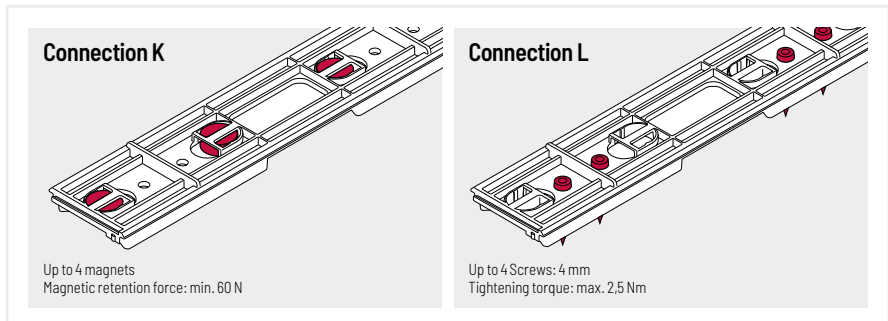

Connection M – for profiles flat

Connection for installing the cable routing on aluminum profiles rectangular.
Fixing via integrated clip.

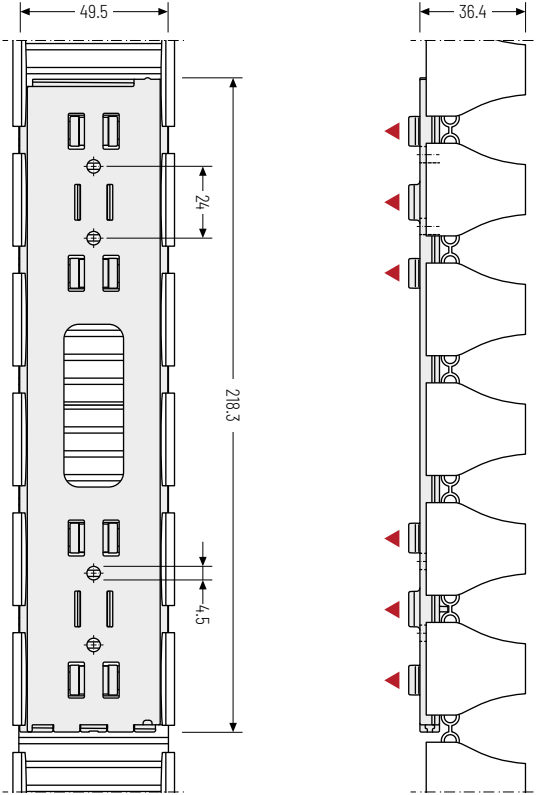

▲ Installation options

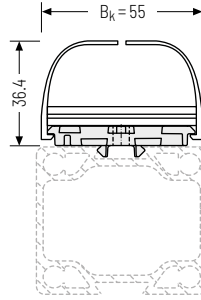

i Individual profile cross-section on request.

Color variants

- Black
Mat. no. 75937*
- White
Mat. no. 75938*
- Silver-gray
Mat. no. 75939*

*SU = 50 pieces

Fixing variant

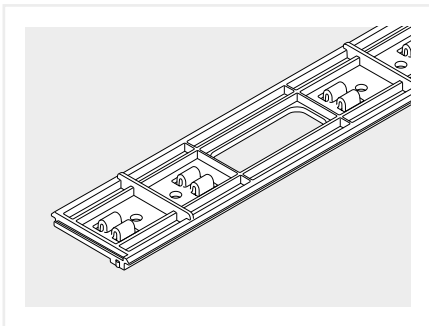

i The assembly depends on the shape of the aluminum profile. Please contact us - we are happy to advise you

Connection N – oval for table top

Table connection for installing the cable routing underneath the table top or on a cable conduit via integrated magnets.

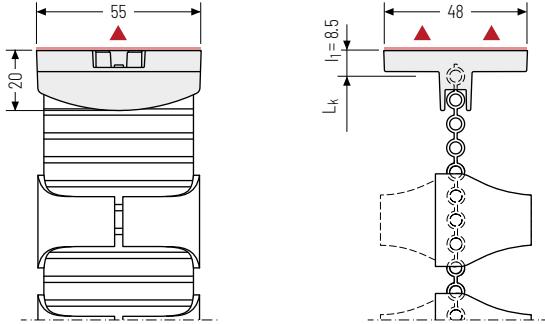
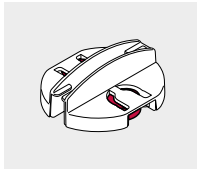
**Fixing variant**

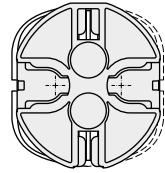

Magnets
Magnetic retention
force:
max. 35 N

▲ Installation options



 Self-adhesive counterholder available for non-magnetic surfaces!

Color variants

-  Black
Mat. no. 75937*
-  White
Mat. no. 75938*
-  Silver-gray
Mat. no. 75939*

*SU = 50 pieces

Side parts „Clip“ – Fixing kit for connection on both sides

Connection for installing the cable routing and attachments such as connector strips, adapters and much more. Fixing with integrated magnets or screws.

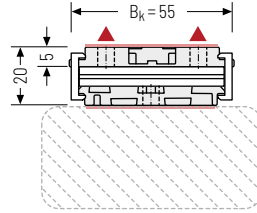
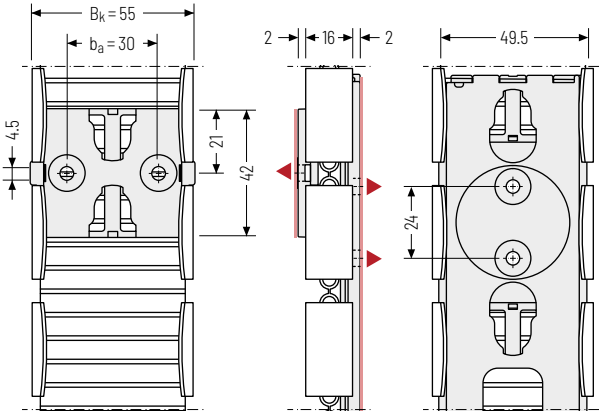

▲ Installation options



 Self-adhesive counterholder available for non-magnetic surfaces!

The fixing kit includes the belt and the side parts "Clip" for a length of 480 mm. The side parts "Clip" can be combined with the following connectors:

Color variants

-  Black
Mat. no. 75812*
-  White
Mat. no. 75814*
-  Silver-gray
Mat. no. 75813*

* Length: 480 mm

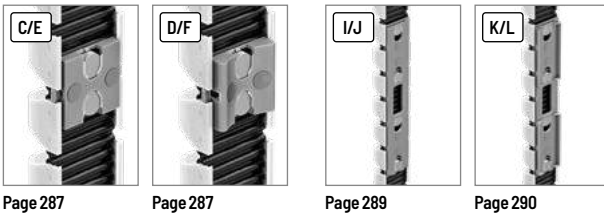

Page 287

Page 287

Page 289

Page 290



Side parts „Clip“

Subject to change without notice.

PROTUM® series	
K series	UNIFLEX Advanced series
M series	TKHD series
XL series	QUANTUM® series
TKR series	TKA series
TKA series	UAT series

Order

Standard sets for height-adjustable tables (standing/seated work stations) up to 740 mm lifting height

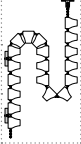
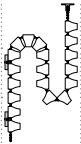
		Color	Order no. Set
K series		Standard set Protum Office P0400GS01 for standing/seated work station for one-sided cable laying , total length 1350 mm incl. 1 connection B and 2 connections F for installation underneath a table top and on a round table frame (D=70 mm)	● Black 75968
		○ White 75970	
		● Silver-gray 75969	
UNIFLEX Advanced series		Standard set Protum Office P0400GS01 for standing/seated work station for one-sided cable laying , total length 1350 mm incl. 1 connection B and 2 connections E for installation underneath a table top and on a flat table frame	● Black 75964
		○ White 75966	
		● Silver-gray 75965	

Standard sets for non-height adjustable tables (standard work stations)

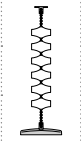
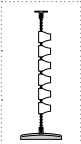
		Color	Order no. Set
M series		Standard set Protum Office P0400GS02 for standard work station for double-sided cable laying , total length 815 mm incl. 1 connection B and 1 connection G for installation underneath a table top and the floor transition	● Black 75960
		○ White 75962	
		● Silver-gray 75961	
TKHD series		Standard set Protum Office P0400GS01 for standard work station for one-sided cable laying , total length 815 mm incl. 1 connection B and 1 connection G for installation underneath a table top and the floor transition	● Black 75956
		○ White 75958	
		● Silver-gray 75957	

Standard sets for attaching a power strip

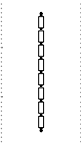
		Color	Order no. Set
QUANTUM® series		Standard set of "Clip" side parts for attaching a power strip . Fastening set for attaching on both sides . Total length 480 mm.	● Black 75835
		○ White 75837	
		● Silver-gray 75836	



Order

Standard sets for cable routing P0400GS01

		Color	Order no. Set
	Standard set for cable routing Protum Office P0400GS01 , inner cross section 50 x 21,5 mm, total length 960 mm.	 Black	75972
		 White	75980
		 Silver-gray	75976

Standard sets for cable routing P0400GS01.2

		Color	Order no. Set
	Standard set for cable routing Protum Office P0400GS01.2 , inner cross section 2 x (51 x 21,5 mm), total length 960 mm.	 Black	75855
		 White	75857
		 Silver-gray	75856

Standard sets for cable routing P0400GS02

		Color	Order no. Set
	Standard set for cable routing Protum Office P0400GS02 , inner cross section 2 x (50 x 21,5 mm), total length 960 mm.	 Black	75981
		 White	75989
		 Silver-gray	75985

All sets are delivered packaged in a box including fixing materials and installation instructions. The order number applies for 1 set / 1 sales unit (SU) = 50 sets. Individual sets only for bulk buyers on request.

 Colored items may have color differences.



PROTUM®
series

K
series

UNIFLEX
Advanced
series

M
series

TKHD
series

XL
series

QUANTUM®
series

TKR
series

TKA
series

UAT
series